

Digital Controller **COMPACT CONTROLLER M [CC-M]** (PROGRAMMABLE CONTINUOUS OUTPUT TYPE)

DATA SHEET

PDA3

The Compact Controller M (programmable continuous output type) is a multi-loop process controller.

It accepts 1 to 5 V DC and signals from thermocouples and resistance bulb as input, and is provided with abundant control and computation functions to allow configuring a flexible system with a high cost performance.

FEATURES

1. Multi-loop controller of up to 4 control outputs.

CC-M has max.4 control outputs, that is real 4-loop multi-loop controller.

[Note] In this data sheet, the term "loop" is used in the same meaning as the quantity of control output.

2. Control and computation functions dependent on wafers

Control and computation functions are implemented by combining function-software packages called "WAFERS." Since the WAFERS are built in the controller, optimum system can be programmed by using the front-panel keys and the PC based configurator.

3. High visibility ensured with color graphic display

A color LCD is adopted for graphic display of multi-loop bar graph and trend screens, etc.

4. Communication function (option)

RS-485 (Modbus[®] protocol or OPTO22 interface[®]) are available.

5. Soft logic function (option)

PLC function can be implemented by IEC61131-3 standard programming language through the PC based configuration software.

6. Back-up (option)

If the controller becomes faulty, influence over the system can be evaded by changing the built-in backup operation unit.

7. Memory card (option)

Memory card can save any data, for example process input, WAFER output, etc.

SPECIFICATIONS

1. Control and Computation Functions

Control and computation functions are implemented by combining function-software packages called "WAFERS." Combination of WAFERS is called "WAFER connection." CC-M comprises 100 kinds of WAFERS. WAFER connection is made by operating the keys on the front panel or using the PC based configurator.



(1) PID control

• Number of loops and PID

: Selectable among the following
1 loop (1 control output / 2PID)
2 loops (2 control outputs / 4PID)
4 loops (4 control outputs / 8PID)

• Proportional band (P)

: 1.0 to 3276.7%, set at 3000.0% for delivery

• Integration time (I)

: 0.1 to 3276.7 s, set at 3000.0 s for delivery

• Derivative time (D)

: 0.0 to 900.0 s, set at 0.0 s for delivery

(2) Programming function

• Programming method

: WAFER connection

• Program capacity

: 48 WAFERS x 4 loops (max. 192 WAFERS)
A maximum of 48 WAFERS usable in 1 loop

• Kind of wafer : 100 kinds listed in Table 1

(3) Computation cycle

: 200 ms for 4-loop (8PID) control of simplicity PID

(4) Alarm function

• Method

: Alarm can be displayed and output through WAFER connection.

• Kinds

: Each high/low of PV, SV and MV, PV change rate alarm, MV change rate alarm, high/low deviations.

2. Input Signals

Performance under reference condition ($23 \pm 2^\circ\text{C}$, $55 \pm 10\% \text{RH}$, Power voltage and frequency variation $\pm 1\%$, free from the effect of external noise) unless otherwise specified.

2-1 Analog input signal

- Number of inputs

8 inputs

- Inpute signal types:

DC voltage, thermocouple (option), resistance bulb (option)

Two thermocouple inputs or two resistance bulb inputs are selectable.

- (1) DC voltage

- Input range: Selectable among 0 to 5 V DC, 1 to 5 V DC and 0 to 10 V DC

Initial set before delivery : 1 to 5 V DC

- Input accuracy: $\pm 0.1\%$ of input span ± 1 digit

- Scaling (Engineering data conversion) : Settable within a range from -32767 to 32767

4, 3, 2, 1 or 0 digit below decimal point is selectable.

Initial set before delivery : 0.00% to 100.00%

- Engineering unit: Settable in up to 8 characters

Usable characters: Alphabets numerals, symbols such as +, -, *, etc.

- Input accuracy guarantee range: -5% to 105% of input range.

- Maximum continuous permissible voltage: $\pm 35 \text{ V}$

- Input resistance: $1 \text{ M}\Omega$ or more

- Influence by ambient temperature: $\pm 0.1\% \text{ FS}/10^\circ\text{C}$ or less.

- Influence by power supply fluctuation: $\pm 0.1\% \text{ FS}$ or less.

- Isolation : Non-isolated from internal circuit.

- In case of current input:

Shunt resistor need to be connected to the analog input terminal.

(250 Ω shunt resistor is optional item)

- (2) Thermocouple (option)

- Types and measurable ranges:

* See Table 2.

- Input accuracy: $\pm 0.2\% \text{ FS} \pm 1$ digit

[Note]B type: $\pm 5\%$ between 0 to 400°C

S and R type: $\pm 1\%$ between 0 to 500°C

All type of TC: $\pm 5\%$ under -100°C

- Reference junction compensation error: $\pm 1.0^\circ\text{C}$ (provided measurable range is -50°C and higher)

[Note]Reference junction compensation resistor is connected at external input terminal in case of thermocouple input is ordered.

- Input accuracy guarantee range: -5% to 105% of input range.

- Input resistance: $1 \text{ M}\Omega$ or more

- Allowable signal source resistance: 100Ω or less (Zener barrier connection unallowable)

- Influence by signal source resistance:

About $0.25 \mu\text{V}/\Omega$

- Influence by ambient temperature:

$\pm 0.2\% \text{ FS}/10^\circ\text{C} \pm 1^\circ\text{C}$ or less.

- Influence by power supply fluctuation:

$\pm 0.2\% \text{ FS} \pm 1^\circ\text{C}$ or less

- Burnout detection: Provided

- Isolation: Isolated from internal circuit.

(3) Resistance bulb (option)

- Types and measurable ranges:

* See Table 2.

- Input accuracy: $\pm 0.2\% \text{ FS} \pm 1$ digit

- Input accuracy guarantee range:

-5% to 105% of input range

- Allowable wiring resistance: 10Ω or less per wire, provided wiring resistance must be equal among 3 wires (Zener barrier connection unallowable)

- Influence by ambient temperature: $\pm 0.2\% \text{ FS}/10^\circ\text{C}$ or less.

- Influence by power supply fluctuation: $\pm 0.2\% \text{ FS}$ or less

- Burnout detection: Provided

- Isolation: Isolated from internal circuit.

[Note] FS: full span.

- Sampling period

: 100 ms

2-2 Digital input signal

- Number of inputs

: 10 inputs

- Electrical specifications

: No-voltage contact or transistor contact
ON/0 V, OFF/24 V, ON current/about 8 mA

Isolated from the internal circuit by photocoupler. Not isolated between each digital input and output.

- Contact rating : 30 V DC, 10 mA or more

- Signal judgment

: No-voltage contact

Contact resistance;

200 Ω or less at ON,

100 k Ω or more at OFF

: Transistor contact

1V max at ON.,

leakage current 100 μA max. at OFF

3. Output Signals

Performance under reference condition ($23 \pm 2^\circ\text{C}$, $55 \pm 10\% \text{RH}$, Power voltage and frequency variation $\pm 1\%$, free from the effect of external noise) unless otherwise specified.

3-1 Analog output signal

(1) Control output

- Number of outputs

: Selectable among 1, 2 and 4 outputs

- Output signal : 4 to 20 mA DC

- Output accuracy

: $\pm 0.2\% \text{ FS}$

- Load resistance

: 600 Ω or less

- Output accuracy guarantee range : 2 to 22 mA DC
 - Influence by ambient temperature : $\pm 0.2\%$ FS/ 10°C or less
 - Influence by power supply fluctuation : $\pm 0.2\%$ FS or less
 - Isolation : Non-isolated from internal circuit
- (2) Auxiliary analog output
- Number of outputs: : 4 outputs
 - Types of signal : Selectable among 0 to 5 V DC, 1 to 5 V DC and 0 to 10 V DC
Initial set before delivery: 1 to 5 V DC
 - Output accuracy : $\pm 0.1\%$ FS
 - Load resistance : 15 k Ω or more
 - Output guarantee range : 1 to 5 VDC : -12.5% to 112.5%
: 0 to 5 VDC : 0% to 112.5%
: 0 to 10VDC : 0% to 105%
 - Influence by power supply fluctuation : $\pm 0.1\%$ FS or less
 - Isolation : Non-isolated from internal circuit

3-2 Digital output signal

- Number of outputs : 10 outputs
- Electrical specifications : Transistor open collector
1 V max. at ON, 10 μA max at OFF.
Isolated from the internal circuit by photocoupler. Not isolated between each digital input and output.
- Output rating : 30 V DC, 100 mA max. (resistive load)

3-3 Fault output signal (terminal symbol FLT)

- Number of outputs : 1 output
- Electrical specifications : Transistor open collector
1 V max. at ON, 10 μA max at OFF.
Isolated from the internal circuit by photocoupler. Not isolated between each digital input and output.
- Output rating : 30 V DC, 100 mA max. (resistive load)

4. Display

- Display unit : 16 Colors graphic liquid crystal display, with CFL back light and contrast adjust function.
- Contents of display : Menu
: Loop panel (1, 2, 4 and 8 loops)
Bar graph display, digital display, etc.
[Note] The term "loop" hereby indicates the number of control blocks. It does not mean the number of control outputs.
: Tuning screen
: Trend screen (max. 8 screens)
: Alarm and alarm historical screen
: Analog input/output and digital input/output indication screen
: WAFER connection screen
: Parameter setting screen

5. Setting and Operation

(1) Set point setting method

- Setting key : Up key/down key
- Setting speed : About 40 s/FS
- Setting resolution : 0.05% FS/each key press

(2) Control output operation method

- Operation key : Up key, down key and high-speed key
- Operation speed : About 40 s/FS (usual),
about 8 s/FS (high speed)

(3) Operation mode

- Kinds of operation mode : C, A, and M
[Note] C : Cascade mode (operation according to remote set point)
A : Auto mode (operation according to the local set point)
M : Manual mode (control output to be manually operated by operator)
- Changeover : Balance bumpless changeover from Auto to Cascade
Balanceless bumpless in other Auto to Cascade
Balanceless bumpless in other changeover

[Note] Balance bumpless changeover is a method where each setting value needs to be balanced by operator himself at the time of changeover. Balanceless bumpless changeover is a method where each setting value is automatically balanced by the controller at the time of changeover.

(4) Security

- Method : Setting of a password
- Password : Settable in 4 numerals (within 0000 to ffff)
Initial set before delivery: 0000
- Contents of security : Inhibition of parameter setting

(5) Other setting items

- Tag name : Settable in up to 8 characters
Usable characters; alphabes, numerals, symboles such as +, -, *, etc.

6. Power Supply

- Voltage rating : 100 V to 240 V AC/24 V DC
- Allowable range : 85 V to 264 V AC/20 V to 30 V DC
- Frequency : 47 to 63 Hz
- Power consumption : 60 VA or less (100 V to 240 V AC)
: 30 W or less (24 V DC)
- Power supply output voltage (terminal symbol VP and PC) : 20V to 30V DC, max. 40mA

7. General performance and characteristics

- **Insulation resistance**
: 500 V DC, 50 M Ω or more.
- **Dielectric strength**
: 2,000 V AC for 1 minute between power terminal and ground terminal in case of 100 V to 240 V AC power supply
: 500 V AC for 1 minute between power terminal and ground terminal in case of 24 V DC power supply.
: 500 V AC for 1 minute between signal communication terminals and ground terminal
- **Rush current** : 60 A or less. (100 V AC to 240 V AC power supply)
- **Clock** : Set and display year, month, day, hour, minute, second
accuracy : ± 100 ppm except of time lag shorter than 1 s / power ON / OFF action.
- **Memory backup**
: Protection by lithium battery.
(expected battery life is about 2 years under room temperature)
Parameter and program are stored non-volatile memory.

8. Operating and storage conditions

- **Operating temperature**
: 0 to 50°C
: 0 to 40°C in case of multiple mounting
(Temperature change rate
: Max. 10°C / h)
- **Transport and storage temperature**
: -20 to 70°C
(Temperature change rate
: Max. 20°C / h)
- **Operating humidity**
: 5 to 90% RH, condensation unallowable
- **Transport and storage humidity**
: 5 to 95% RH, condensation unallowable
- **Operating continuous vibration**
: 4.9 m/s² or less
- **Transport and storage shock**
: Fall of 60cm max. in packed status

9. Power Failure and restart Function

- **Permissible duration of momentary power failure**
: 20 ms at 90V AC (100 V to 240 V AC only)
In the case of 24V DC, it is recommended to avoid power failure problem that system power supply unit with permissible duration of momentary power failure of 20ms or more (PXJ, for example) is used.
- **Behavior at power failure detection**
: Control stops at detection of power failure.
- **Power recovery mode**
: Selectable initial start and continuous start

10. Self-Diagnosis

- **Control and computation circuit failure**
: Monitoring with watchdog timer
- **Input signal failure**
: Voltage/current input
Monitoring of range over
: Thermocouple and resistance bulb
Monitoring of disconnection
- **Control output signal failure**
: Monitoring of disconnection by read back check
- **Behavior at failure**
: FLT is indicated, FLT lamp lights, FLT output signal turns on, control stops and control output is held.

11. Structure

- **Enclosure** : Plastic (material: PC-ABS)
- **Finish color** : Front frame and enclosure both gray
- **Flame resistance**
: UL94V-0
- **Protection** : Front face: IP54 (display unit and operation key)
- **External dimensions (W x H x D)**
: 72 x 144 x 280 mm
- **Mass** : 1.9 kg or less
- **Mounting method**
: Flush on indoor panel
Vertical mounting as standard
Tilted mounting allowed within backward angle 0° to 45°.

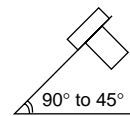

For panel cutout dimension, refer to Panel Cutout Dimensions

- **External terminal**
: Compression terminal type

12. Backup Function (option)

- **Method** : With backup operation unit
- **Number of control outputs**
: 1, 2 or 4 outputs selectable.
- **Indication** : Control output indication of each loop (mA indication)
- **Indicator** : 21-segment LED
- **Indication changeover**
: Changeable to each loop by loop selection key
Loop No. indicated by 1-digit LED
- **Operation key** : Control output up, control output down, loop selection
- **Operation resolution**
: 5%
- **Backup changeover**
: Changeover has been made by the HM (Hard Manual) switch. However, changeover cannot be made when the backup operation unit is faulty.
: In all loops, changeover to the HM mode is blanceless and bumpless.

13. Communications (option)

13-1 RS485 interface-1

- Communication behavior : Slave
- Communication protocol : Modbus[®] protocol
- Physical specification : EIA RS-485
- Communication method : Half-duplex, bit serial
: Start-stop synchronizing
- Connection form : Multi-drop
- Communication speed : 19.2 kbps
- Communication distance : Max. 500 m in total
- Number of connectable units : Max. 31 units
- Data length : Fixed to 8 bits
- Parity : Odd / Even / None
- Stop bit : 1 or 2
- Isolation : Isolated from internal circuit
- Terminator : 100 Ω (optional item)
- Communication items : Parameters and process value.
- RS232C / RS485 signal converter (optional item) : Code symbol: PDZT0001

13-2 RS485 interface-2

- Communication behavior : Master
- Usage : I/O extension
Analog input / output : Max.4
Digital input / output : Max.32
- Communication protocol : OPTO22 interface[®]
- Physical specification : EIA RS485
- Communication method : Half-duplex, bit serial
: Start-stop synchronizing
- Communication speed : 57.6 kbps
- Communication distance : Max.50m in total
- Number of connectable units : Max.31 units
[Note] Number of units is limited depend on the number of I/O points.
- Isolation : Isolated from internal circuit
- Terminator : 100 Ω (optional item)
- Communication item : Parameters, process values, etc.
- Connectable slave unit : SNAP I/O series[®] (OPTO22 corporation)

14. Soft logic function (option)

[Note] The both of soft logic function and WAFER is not available to operate one time.

- Programming method : Based on IEC 61131-3
available language;
Ladder diagram (LD)
Sequential function chart (SFC)
Function block diagram (FBD)
: Programming is to be carried out using the PC based configuration software.
Programming and editing are not allowed on the controller
- Number of steps : 2k steps of ladder
- Computation cycle : 200 ms / 2k steps of ladder

15. Memory Card Interface (option)

- Specification : Compact Flash[®] (Based on CFA)
- Compatible memory card : 5 V flash memory card
Capacity 4, 20 and 32 MB
- Application : Process data logging (32 points or less)
- Saving period : 1s to 2h
- Data storage capacity

Memory card capacity	Data storage
4MB	about 180 thousand data
20MB	about 900 thousand data
32MB	about 1.35 million data

[Note] The data of max. 16 points (4 screens) can be stored at storage time as 1 s.

- Format method : Dependent on this controller
- Data readout : Readout by PC using PCMCIA card slot
- Recommended memory card : Made by Sandisk corporation
Sandisk compact Flash memory card is standardized and on the market.

16. Standards under Conformity

(1) General safety

- : IEC 1010-1 (1990)
- EN 61010-1 (1993)

(2) EMC

- : Emission EN 50081-2 (1994)
- Immunity EN 50082-2 (1995)

17. Configuration Software

17-1 Programming loader software

(code symbol : PDZP2001)

This software is installed on the CD-ROM form instruction manual (PDZQ2001) supplied with the main unit.

Communication cable (PDZL1001) is optionally available.

- WAFER connection can be entered, edited, uploaded and downloaded.
- Operation parameter can be entered, edited, uploaded and downloaded.

17-2 Soft logic configurator (optional item)

(code symbol : ZOZ *C-KDS-WD2A)

• Programming method

- : Based on IEC 61131-3

[Note] The program made by this software cannot be changed by the controller function key.

17-3 Recommended personal computer system

- **Hardware** : DOS/V machine, Pentium™ 100MHz or higher
Free hard disk capacity 40MB or more, memory capacity 32MB or more
- **Operating system** : Windows 95™/98 SE

17-4 Cable (code symbol : PDZL1001)

Using the configuration software, the configuration file is downloaded via RS232C transmission cable.

**Table 1
List of WAFERS**

WAFER name	Kinds	Outline
Primary PID	9	Carries out computation on the primary loop.
Secondary PID	5	Carries out computation on the secondary loop.
Gain schedule	2	Outputs the PID parameter corresponding to input 1 according to the gain schedule table.
Bit concatenate	8	Outputs digital data as word data to an external expansion I/O.
Bit slicing	1	Slices the digital data acquired as word data from an external expansion I/O into each bit.
Encoder	1	Encodes an input signal into a binary code.
Sawtooth wave generator	1	Generates a sawtooth wave with a slope entered for each cycle time.
BCD	5	Converts BCD data into binary data and binary data into BCD data.
Logical operation	6	Carries out AND, OR, NOT, XOR and a combination of these logical operations.
Arithmetic operation	8	Carries out a combination of addition, subtraction, multiplication and division.
Temperature/pressure compensation	1	Carries out temperature and pressure compensation through use of differential pressure, compensated pressure, proper temperature.

WAFER name	Kinds	Outline
Linearize	7	Carries out segmented-line approximation with 15-segmented-line function.
Program control	4	Time schedule control by step or polygonal line approximation with 7 segments.
Flip-flop	1	RS flip-flop.
Pulse width integration	1	Adds the change of input at each basic cycle to the previous integration value.
Selector	1	Compares two input values, and provides High output(Large one), Low output(Small one), and result of judgement on large/small.
Changeover	1	Selects input or output via a switch function. Analog hold circuit also provided.
Timer	1	Outputs on-delay, off-delay timer signal via start of input signal according to timer setting.
Absolute value/sign inversion	1	Carries out absolute value processing on input and outputs the result. Also judges the sign(Positive, negative) of input value and outputs the result.
Square root extraction	1	Extracts square root of input value and outputs the result. Low input cutoff function equipped.
Lead, lag	3	Carries out lead/lag operation on the input and outputs the results. Used as analog filter function and for various compensations.
Limiter	1	Limits the input within the range of high/low limit settings, and outputs the result. Also outputs high/low limit alarm signal.
Ramp function	2	Outputs signal which changes...in ramp from toward target value at the set full scale time. There are two of these wafers...in minute unit and hour unit.
Analog averaging	1	Carries out sequential integration on input data, calculates the average value at each averaging time, and outputs the result.
Analog integration	1	Integrates the value obtained by multiplying the input data by a proportional constant, and outputs the result.
Pulse generation	1	Outputs a pulse at the set time interval.
Dead band	1	Adds dead band compensation to the input and outputs the result.
Pulse No. counter	1	Detects rise of pulse and counts the number of pulses.
Pulse No. output	1	Integrates the input signal and converts it to number of pulses for output.
Decoder	1	Decodes 2-bit pure binary input and outputs it to 4 terminals.
Running average	2	Calculates running average of input data and outputs the result.
Sample & hold	1	Holds the input value according to sample signal(0/1) and continues the output.
Dead time	6	Usable for dead time compensation control etc. Data sampling can be done in 1 sec or 1 min units.
ON-OFF	1	Outputs ON-OFF signal with hysteresis.
Alarm	1	Compares the input and set value and outputs the judgment result.
Pulse width modulator	1	Performs output processing in time proportional PID control.
Indicator	8	Indicate input data on the front display (using 3 bar-graph display)

A variety of applications are possible through combination of WAFERS.

Table 2

List of Thermocouple and Resistance Bulb Measurable range

	Input signal	Input type code	Input range code	Measurable range °C
Thermocouple	J	01	00	0.0-400.0
	J		01	0.0-800.0
	K		02	0.0-400.0
	K		03	0.0-800.0
	K		04	0.0-1200.0
	R		05	0.0-1600.0
	B		06	0.0-1800.0
	T		07	-200.0-200.0
	T		08	-150.0-400.0
	E		09	0.0-800.0
	E		10	-200.0-800.0
	S		11	0.0-1600.0
	N		12	0.0-1300.0
	U		13	-200.0-400.0
	WRe5-26		14	0.0-2300.0
PL II	15	0.0-1300.0		
Resistance bulb	Pt100	00	00	0.0-150.0
			01	0.0-300.0
			02	0.0-500.0
			03	0.0-600.0
			04	-50.0-100.0
			05	-100.0-200.0
			06	-200.0-600.0
			07	-200.0-850.0

SCOPE OF DELIVERY

Controller, panel mounting bracket, instruction manual (depend on code symbols)

Optional Items

Item	Type	Specification	Available unit
Terminator for communication (100 Ω)	PDZR2001	For compression terminal	1
Shunt resistor (250 Ω)	PDZS2001	For compression terminal	1
Communication cable for configuration software	PDZL1001	Commonly usable cable for configuration software (3m length)	1
Communication cable (Note1) For compression terminal, from PDA to PDA	PDZK4xx1	With compression terminal at both ends	1
For compression terminal, from PDA to PLC	PDZK5xx1	With M3.5 solderless terminal on PLC side	1
For compression terminal, from PDA to PC	PDZK6xx1	9-pin connector on PC side	1
Communication converter	PDZT0001	RS232C / RS485 signal converter	1
Compact Controller M (CC-M) Instruction Manual in book form (in English)	PDZX5001	Instruction manual in book form	1
Compact Controller M (CC-M) Introductory Guide in book form (in English)	PDZX4001	Instruction manual in book form	1
Instruction Manual on CD-ROM (in Japanese and English) (Note2)	PDZQ2001	Instruction manual on CD-ROM	1
Mounting bracket (Note3)	PDZA1001	Improved mounting bracket	1

- (Note 1) These cables are used for Modbus®. Length needs to be specified.
- (Note 2) The instruction manual, introductory guide and programming loader software (PDZP2001) are included.
- (Note 3) This is the improved mounting bracket adopted from PDA-2. Refer to the outline diagram for shape and dimensions.

Block diagram of electrical isolation

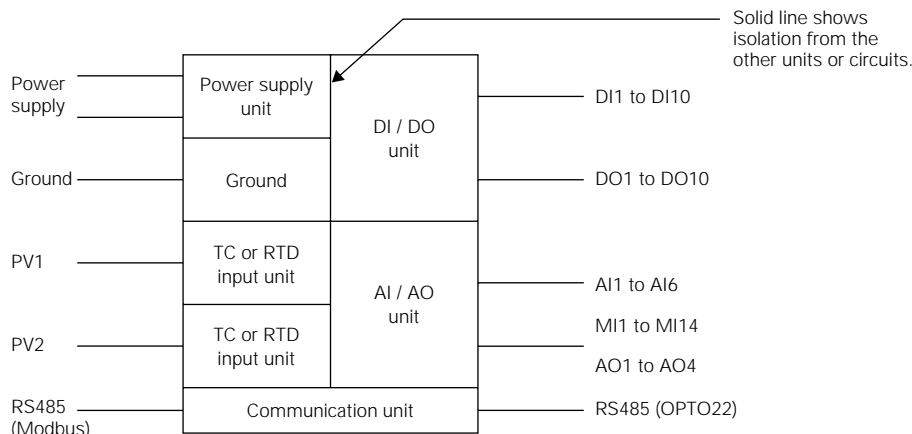

CODE SYMBOLS

1	2	3	4	5	6	7	8	9	10	11	12	13	14	15	Description
P	D	A					1								Controller function <4th digit code> Programmable type
		3													Note 1
			1												Number of control loops <5th digit code>
			2												1 loop (1 control output)
			4												2 loops (2 control outputs)
															4 loops (4 control outputs)
				2											External terminal <6th digit code> Compression terminal
					A										Input signal <7th digit code> 1 to 5 V DC
					C										Thermocouple
					D										Resistance bulb Pt100
															Note 3
															Note 4
															Note 4
															Power supply voltage <9th digit code> 100V to 240V AC (Usable range 85V to 264V AC) 50 / 60Hz
															24V DC (Usable range 20 to 30V DC)
															Operation mode <10th digit code> Cascade-Auto-Manual changeable type
															Backup operation unit <11th digit code> Without
															For 1 control output, 100 to 240 V AC
															For 2 control outputs, 100 to 240 V AC
															For 4 control outputs, 100 to 240 V AC
															For 1 control output, 24 V DC
															For 2 control outputs, 24 V DC
															For 4 control outputs, 24 V DC
															Communication / Memory card interface <12th digit code> (Slave) (Master) (memory card interface)
															Note5 Note6
															Without Without Without
															Without Without With
															RS485 Without Without
															Note7
															RS485 RS485 Without
															Note7
															RS485 Without With
															Note7
															RS485 RS485 With
															Note7
															Instruction manual <13th digit code> Without
															Instruction manual on CD-ROM (in Japanese and English)
															Note11
															Programming method <14th digit code> WAFER connection method
															Soft logic method
															Note 8
															Factory configuration<15th digit code> Without WAFER connection
															Note 9
															With up to 48 WAFER connection
															Note10
															With more than 49 WAFER connection
															Note10

Note 1) Control and computation function could be done by WAFER connection or soft logic function.

Note 2) Control loop means the number of control output.

Note 3) For current input, a shunt resistor is used for conversion into voltage.
Shunt resistor is optional item.

Note 4) Thermocouple and resistance bulb input are optional items.
Allowable up to 2 points.

Note 5) Communication cable and terminator are optional items.

Note 6) Recommended maker: Sandisk corporation.

Note 7) Slave interface is Modbus[®] protocol and master interface is OPTO22 interface[®].

Note 8) Programming method conforming with IEC61131-3.

Optional items Soft logic configurator is necessary for programming.

The both of Soft logic function and WAFER is not available to operate one time.

Note 9) In this case, WAFER connection programming should be made by user.

Connection tool (Programming loader) is optional item.

When set "2" on the 14th digit code, "0" should be set on the 15th digit code.

Note 10) WAFER connection specification sheets need to be prepared and submitted by user to Fuji.

Input signal and measurable range initial set before delivery is as follows.

For specification of voltage input, scale is 0.00 to 100.00%

For specification of thermocouple, K, 0.0 to 400.0°C.

For specification of resistance bulb is 0.0 to 150.0°C.

Note 11) Programming Loader (PDZP2001) is included in the CD-ROM.

Communication cable (PDZL1001) is optionally available.

This instruction manual is recorded in PDF format file. To read this manual,

Adobe Acrobat Reader is required. Setup program of Acrobat Reader is also

recorded on this CD-ROM.

FUNCTIONAL DIAGRAM

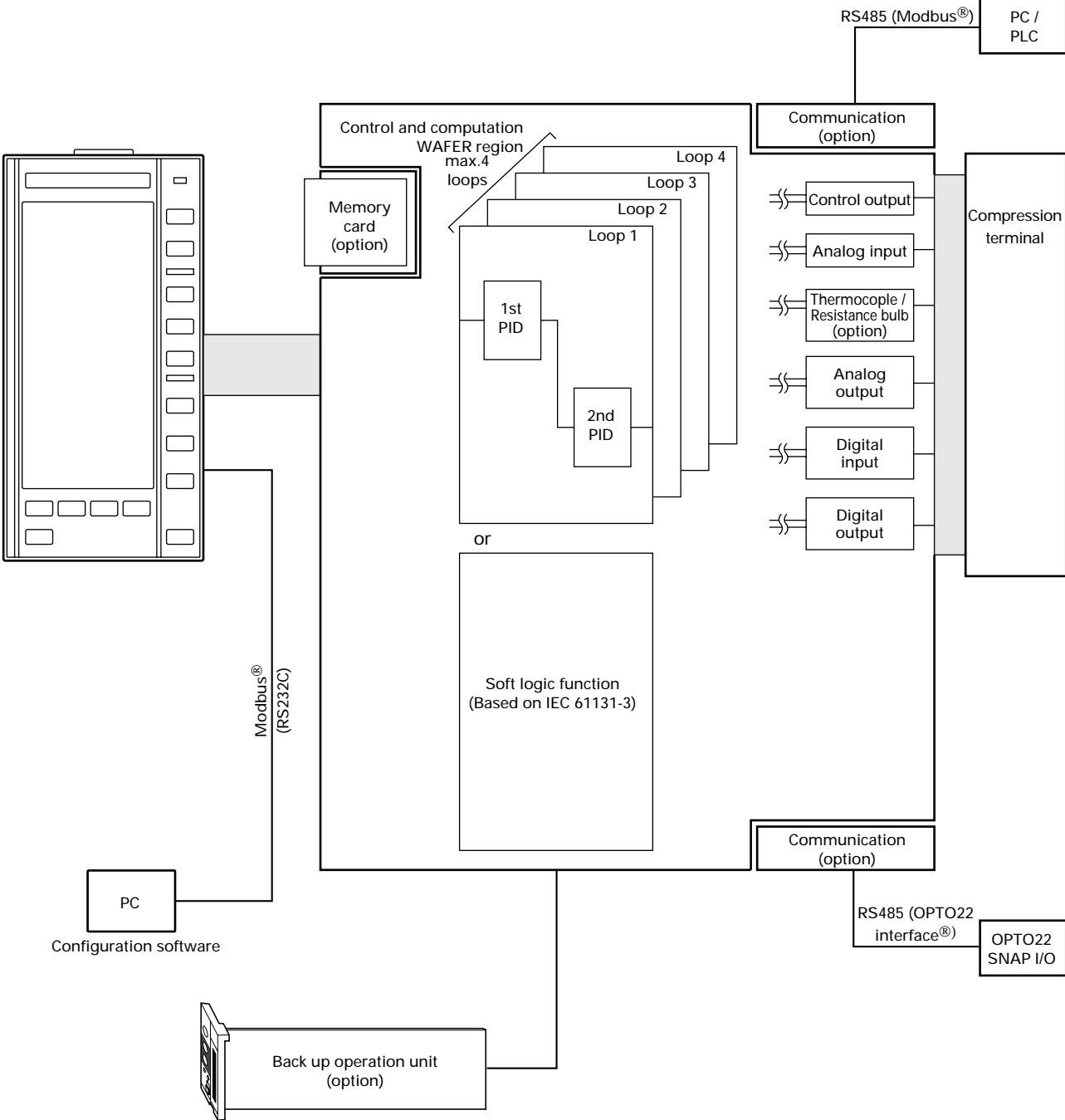

OUTLINE DIAGRAM (Unit : mm)

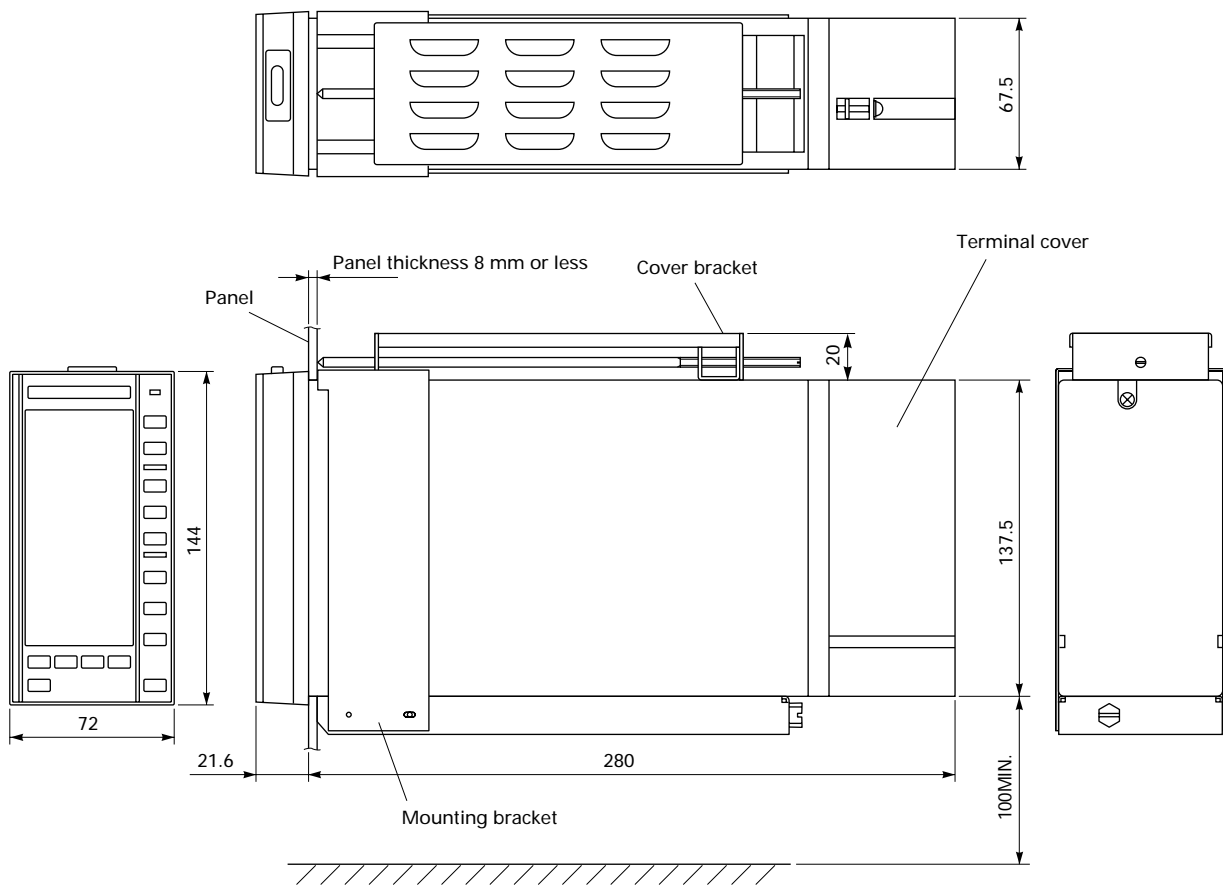

Note) The distance between other instruments and low end of PDA shall be more than 100mm.

MOUNTING BRACKET

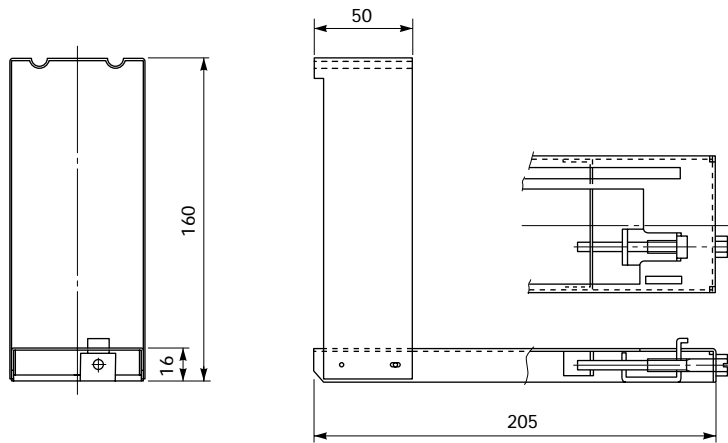

PANEL CUTOUT DIMENSIONS

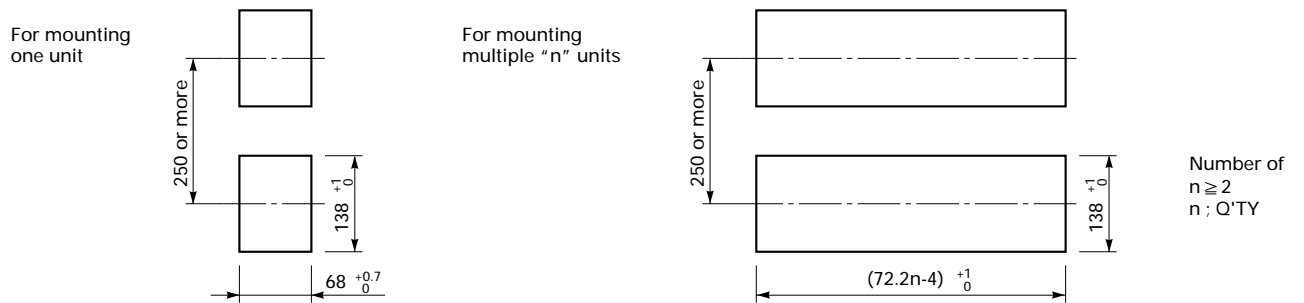

EXTERNAL CONNECTION DIAGRAM

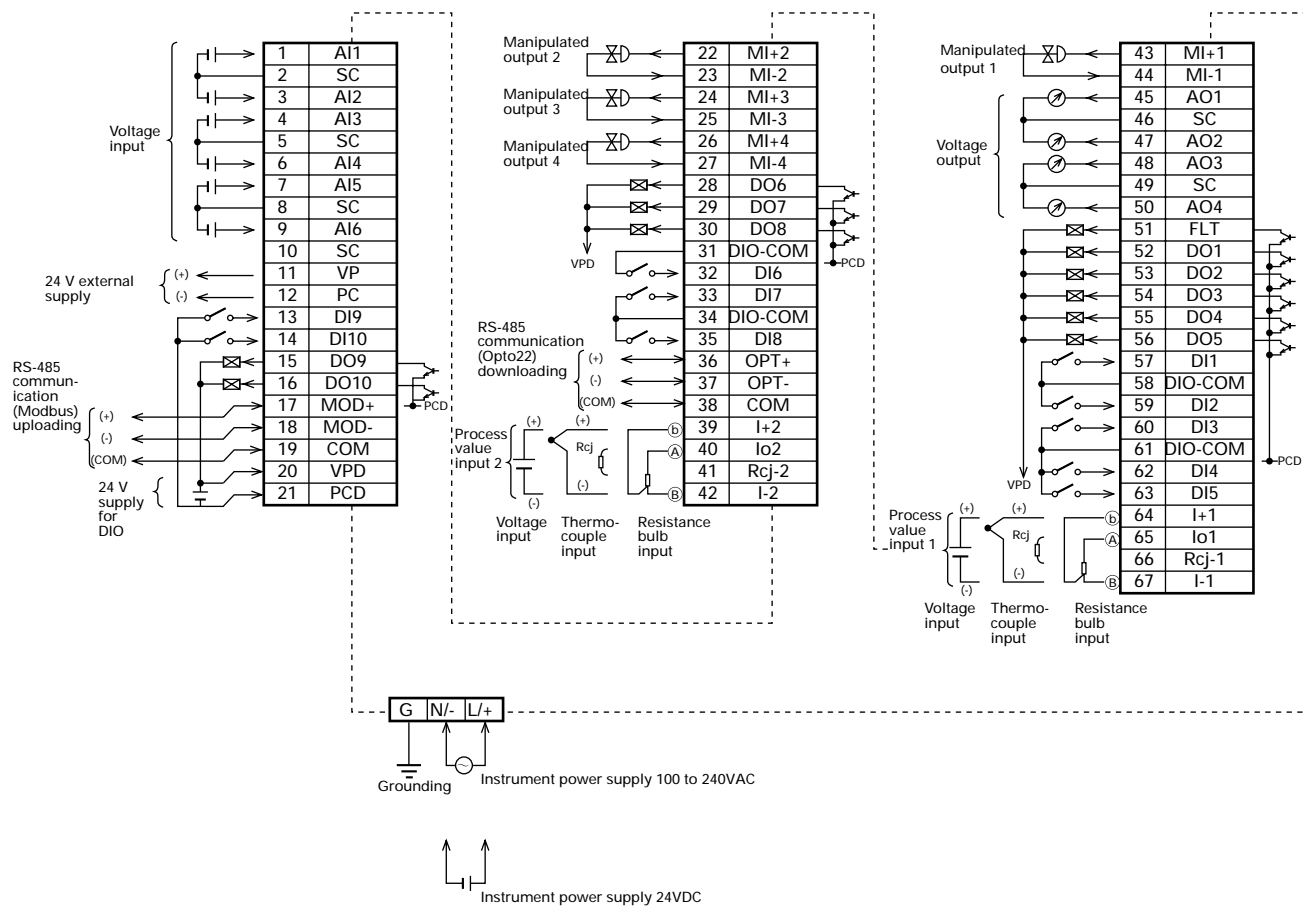

[Note] Windows 95 is the registered trade mark of Microsoft corporation.

[Note] Modbus® is the registered trade mark of Gould Modicon.

[Note] Compact Flash® is the registered trade mark of Sandisk corporation.

[Note] OPTO22 interface and SNAP I/O is the registered trade mark of OPTO22(USA).

[Note] Adobe and Acrobat are trademarks of Adobe Systems Incorporated.

⚠ Caution on Safety

*Before using this product, be sure to read its instruction manual in advance.

Fuji Electric Co.,Ltd.

Head office

11-2 Osaki 1-chome, Shinagawa-ku, Tokyo, 141-0032 Japan
<http://www.fujielectric.co.jp>

Fuji Electric Instruments Co.,Ltd.

Sales Div.

International Sales Dept.

No.1, Fuji-machi, Hino-city, Tokyo, 191-8502 Japan
 Phone: 81-42-585-6201, 6202
 Fax: 81-42-585-6187, 6189
<http://www.fic-net.co.jp>